



Waste disposal with a system

Planning, Installation and Maintenance – Everything from a single source!

Our units are used in the most varied sectors

- **Aluminium industry**
- **Printing and paper industry**
- **Waste and recycling industry**
- **Hardening plants**
- **Foil and Network industry**
- **Drinks and tin can industry**
- **Materials industry**
- **Machine and plant engineering**

A few companies have already been able to considerably reduce their operating costs by converting to our systems. This customer satisfaction ensures long-term and smooth cooperation.

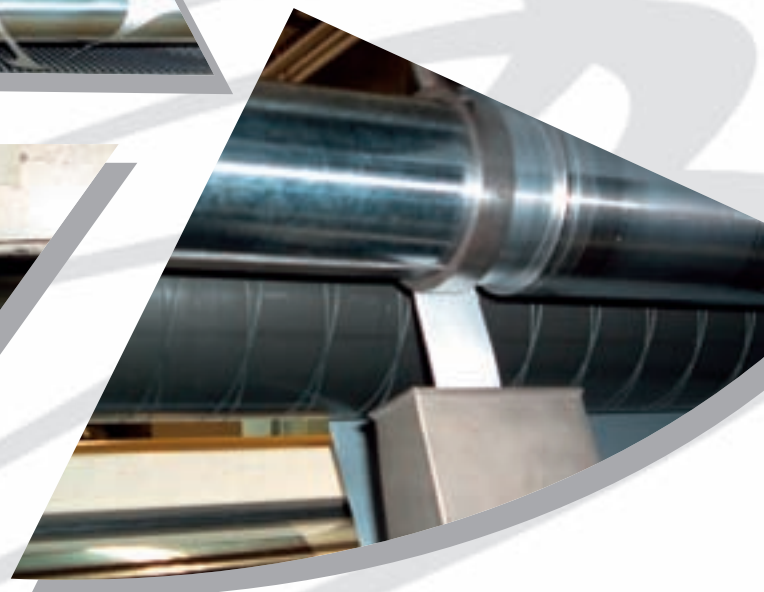
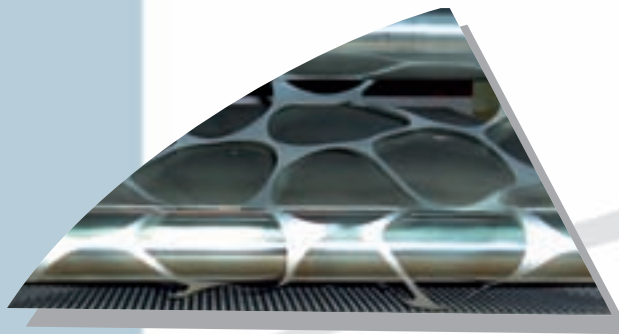

Waste disposal with a system pays off!

Fields of application

Our credentials and the years of experience in the planning, installation and maintenance of modern units make us a competent partner beyond the borders of Germany.

In order to ensure higher availability of our units, we place special importance on a long service life, operational safety and maintainability of our components.

This guarantees high quality machines across the whole range of sectors.

Different extraction possibilities are available depending on application. The robust, variable system opens up a wide range of use in the processing and disposal of production waste.

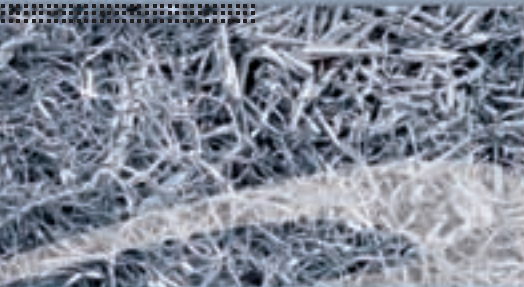
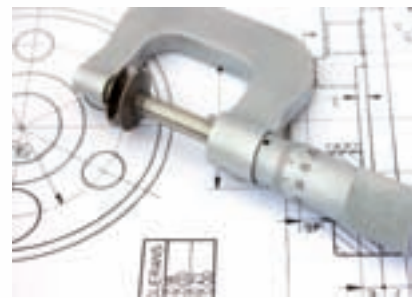

Metal filings



Brass / copper foil



Aluminium foil

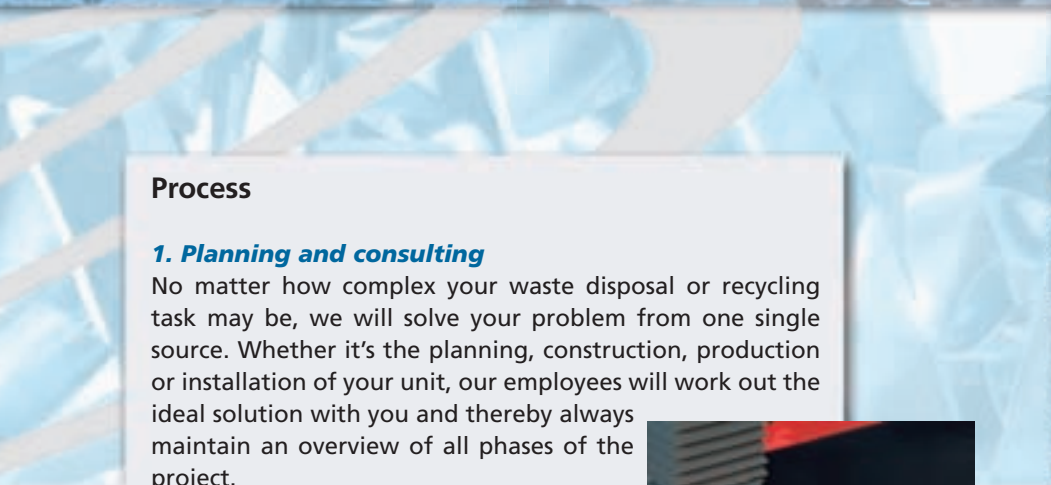

Plastic chippings

Process

1. Planning and consulting

No matter how complex your waste disposal or recycling task may be, we will solve your problem from one single source. Whether it's the planning, construction, production or installation of your unit, our employees will work out the ideal solution with you and thereby always maintain an overview of all phases of the project.

An experienced project manager will support you throughout each phase with comprehensive advice and expertise and is a constant point of contact for you.

The continuous interchange between the core areas ensures ideal cooperation and the development of the perfect solution for you.

2. Construction and Production

In the construction phase, Deltoid works with the newest technologies in the field of 2 and 3 dimensional CAD. In this way, 3 dimensional unit layouts can be made available for the assembly instructions.



The seamless transition from electronic CAD data to the most up-to-date CNC laser machines ensures the highest precision.

The use of the most valuable materials and the robust construction of our machines ensure a smooth process in the later production process and therefore secure high availability of your unit for you.

In order to guarantee the best running characteristics, each pre-assembled unit is subjected to a check upon exit, which can be carried out in your presence should you so desire.



The extraction units from Deltoid integrate the suction, shredding, transporting and separation of materials into one system.

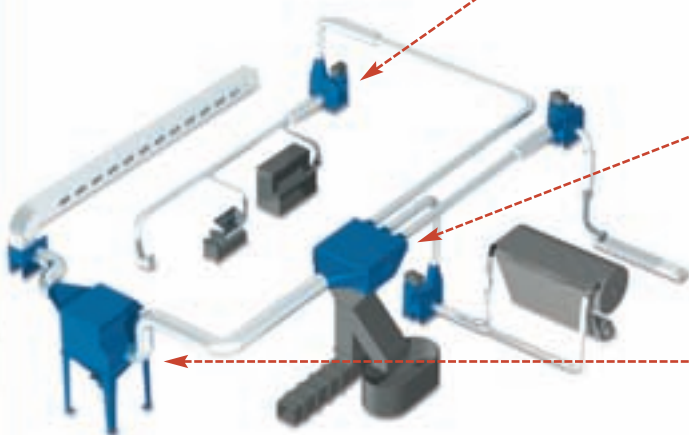

The ZV chopper fan

The chopper fan is characterised by its robust construction, the high efficiency and high pressure through which large amounts of waste can be transported over wide stretches. The impeller wheel with toothed blades made of high-quality special steel secures a long service life and high performance.

The FA material separator

The FA material separator can be housed inside a hall in the majority of cases due to its flat, compact construction. It guarantees an almost pressure-less material discharge and reacts fully insensitively in the case of changing volume of air supplied.

The JP cartridge filter unit

The cartridge filter unit can be installed downstream from the material separator. The high degree of separation enables the return of the conveying into the operating area (energy saving).

Plastic film

Paper and card- Insulating board packaging materials

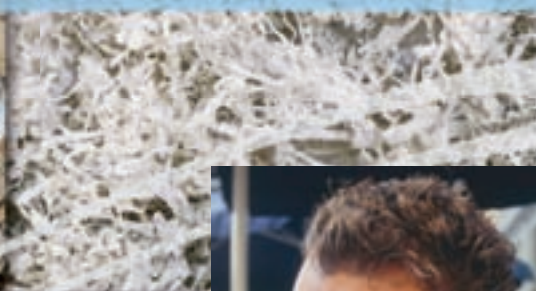

3. Installation and Commissioning

Deltoid embodies the concept "everything from one single source".

Therefore, after the production has taken place, the unit is installed and commissioned by our qualified and trained specialist personnel.

Careful briefing of your employees who deal with our units is self-evident. Electronic documentation is available in PDF format (Acrobat Reader™).

4. Maintenance

We make service capital and for this reason we are naturally available with assistance and advice during operation.

Due to the high quality and precise processing of our machines, almost no maintenance is necessary, however you can take out corresponding maintenance contracts.

Naturally we react immediately to potential incidents and/or maintenance issues.



Deltoid Lufttechnik

How to find us:

From the **A2** take the **A3** towards Arnheim and take the exit Rees/Isselburg. From the **A40** take the **A3** at Kreuz Kaiserberg towards Hannover/Arnheim and then take the exit Rees/Isselburg.

From the Netherlands: take the **A3** towards Oberhausen and leave the motorway at the Rees/Isselburg exit.

After the exit please follow the maps below:

Or visit us on the internet at:

www.deltoid-lufttechnik.de

Here you can download these maps in printable PDF DIN-A4 format. And if you require a more exact description of the route, please use our route planner.



Sketch of directions with motorways A12, A18, A3, A31, A57, A40, A42 and A2.

We are here:

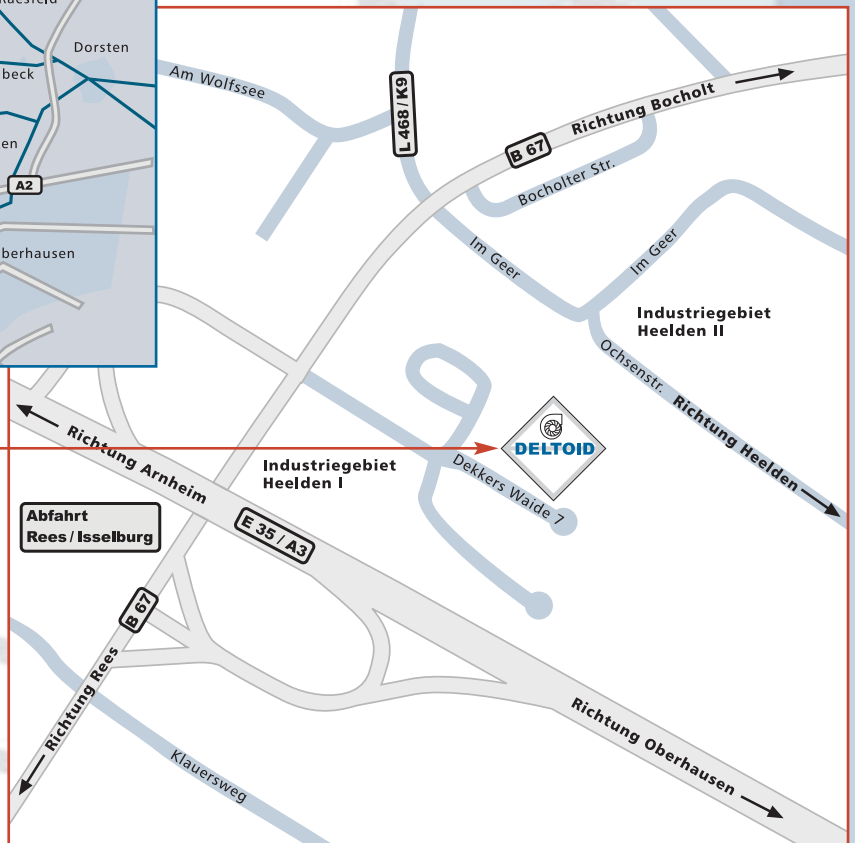

Sketch of directions from the Heelden industrial region.



DELTOID GmbH

Dekkers Waide 7
46419 Isselburg (Germany)

Fon: +49 28 74 / 9 00 86 - 0
Fax: +49 28 74 / 9 00 86 - 29

E-mail: info@deltoid-lufttechnik.com
www.deltoid-lufttechnik.de

